

U-BOX

悦薄收纳分隔系列

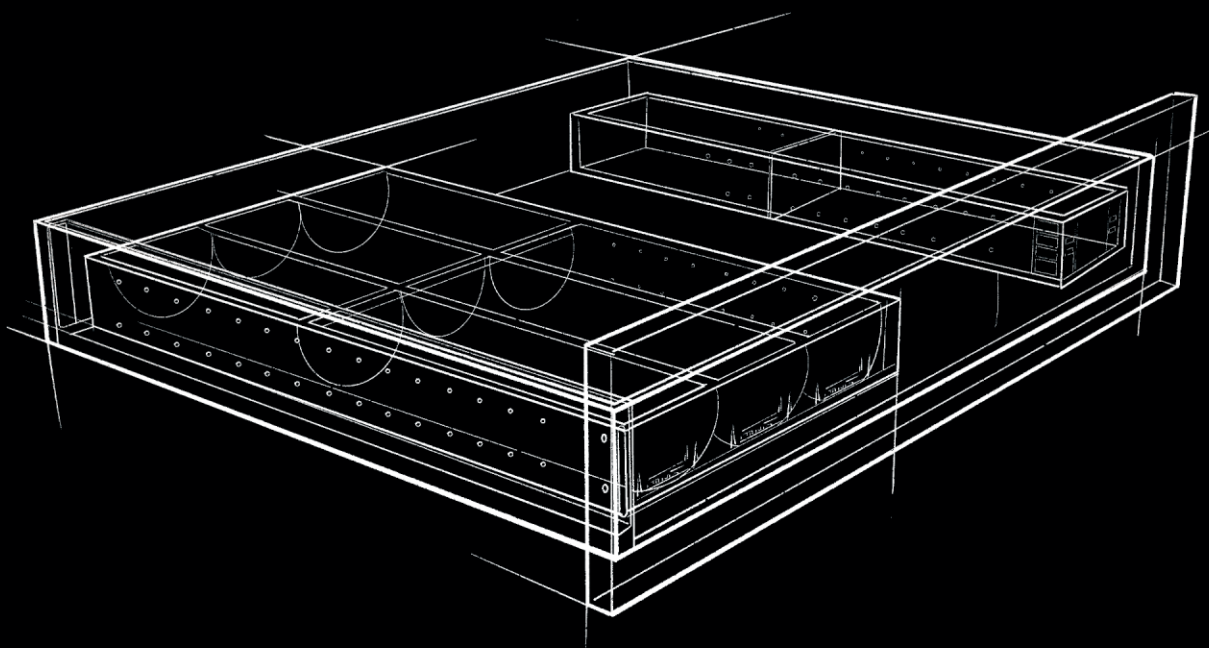

Full of style

细腻明快的线条，
塑造着精致简雅的家居气质随便一装，
格调满满。





产品详情电子版

5311 收纳分隔



标称长度	丝光白	铁灰	数量
350	5311350W	5311350G	6SET
400	5311400W	5311400G	6SET
450	5311450W	5311450G	6SET
500	5311500W	5311500G	6SET
550	5311550W	5311550G	6SET



5312 收纳分隔



标称长度	丝光白	铁灰	数量
350	5312350W	5312350G	6SET
400	5312400W	5312400G	6SET
450	5312450W	5312450G	6SET
500	5312500W	5312500G	6SET
550	5312550W	5312550G	6SET

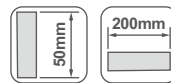

5322 不锈钢餐具盒



标称长度	丝光白	铁灰	数量
450	5321450W	5321450G	6SET
500	5322500W	5322500G	6SET

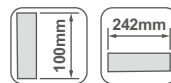

推荐搭配



NL标称长度	产品编号	柜体宽度
450mm	5322450X1	400-500mm
500mm	5322500X1	400-500mm



NL标称长度	产品编号	柜体宽度
450mm	5322450X1+5311450X1	600-800mm
500mm	5322500X1+5311500X1	600-800mm



NL标称长度	产品编号	柜体宽度
450mm	5322450X2+5311450X1	900-1000mm
500mm	5322500X2+5311500X1	900-1000mm



NL标称长度	产品编号	柜体宽度
450mm	5322450X2+5312450X1	1200mm
500mm	5322500X2+5312500X1	1200mm

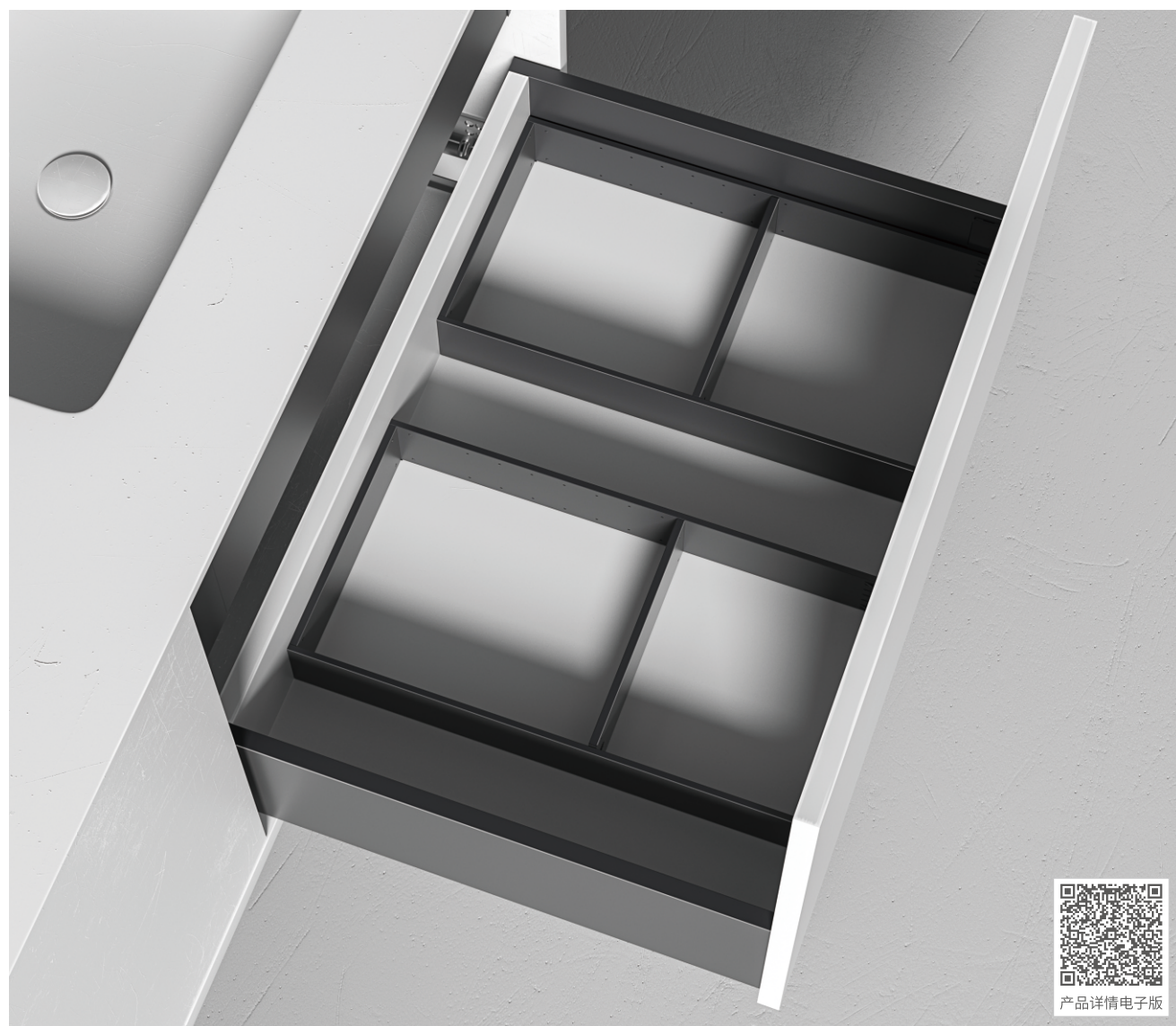

产品描述

分隔系统合理有序，每一件物品都妥帖安放，清晰分明。精湛的工艺，不落俗套的设计，自然流露出空间的高雅气质。可调节式分隔板，打破规则，可自由调节分隔空间大小，让收纳灵活多变。

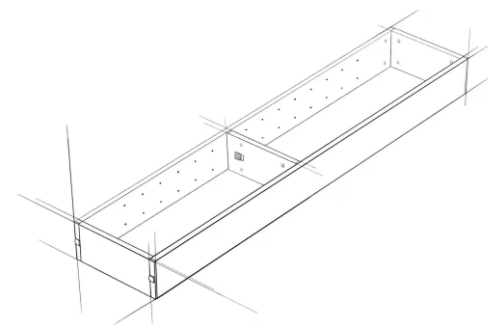

5311 收纳分隔



标称长度	丝光白	铁灰	数量
350	5311350W	5311350G	6SET
400	5311400W	5311400G	6SET
450	5311450W	5311450G	6SET
500	5311500W	5311500G	6SET
550	5311550W	5311550G	6SET

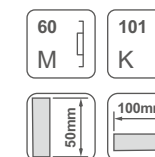

5312 收纳分隔



标称长度	丝光白	铁灰	数量
350	5312350W	5312350G	6SET
400	5312400W	5312400G	6SET
450	5312450W	5312450G	6SET
500	5312500W	5312500G	6SET
550	5312550W	5312550G	6SET

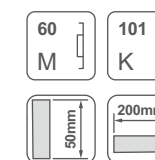

推荐搭配

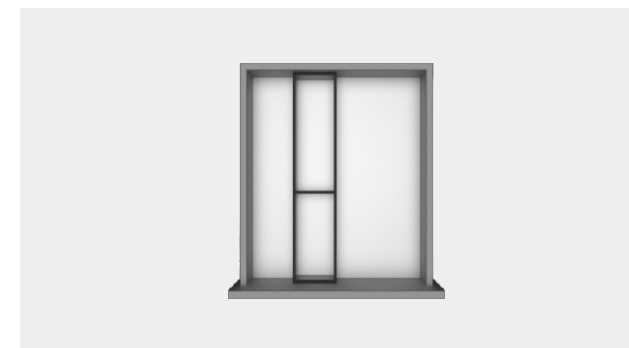

NL标称长度	产品编号	柜体宽度
350-550mm	5311XXX*1	400-500mm



NL标称长度	产品编号	柜体宽度
350-550mm	5311XXX*1+5312XXX*1	600-700mm

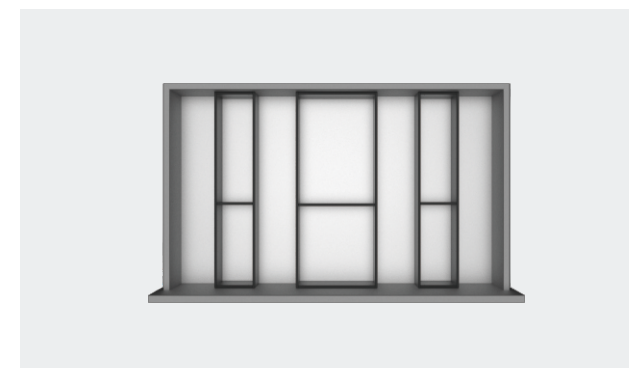

NL标称长度	产品编号	柜体宽度
350-550mm	5311XXX*2+5312XXX*1	800-900mm

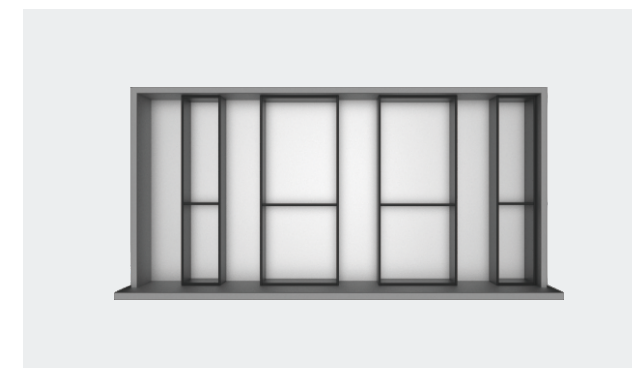

NL标称长度	产品编号	柜体宽度
350-550mm	5311XXX*2+5312XXX*2	1000-1200mm



产品描述

分隔系统合理有序，每一件物品都妥帖安放，清晰分明。精湛的工艺，不落俗套的设计，自然流露出空间的高雅气质。可调节式分隔板，打破规则，可自由调节分隔空间大小，让收纳灵活多变。

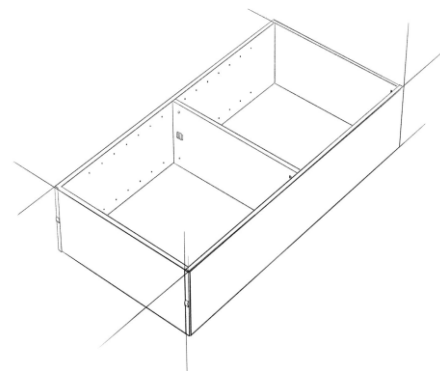

5313 收纳分隔



标称长度	丝光白	铁灰	数量
350	5313350W	5313350G	6SET
400	5313400W	5313400G	6SET
450	5313450W	5313450G	6SET
500	5313500W	5313500G	6SET
550	5313550W	5313550G	6SET

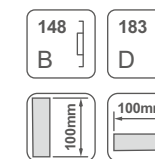

531 收纳分隔



标称长度	丝光白	铁灰	数量
350	5314350W	5314350G	6SET
400	5314400W	5314400G	6SET
450	5314450W	5314450G	6SET
500	5314500W	5314500G	6SET
550	5314550W	5314550G	6SET

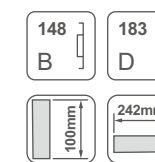

推荐搭配



NL标称长度	产品编号	柜体宽度
350-550mm	5313XXX*1	400-500mm

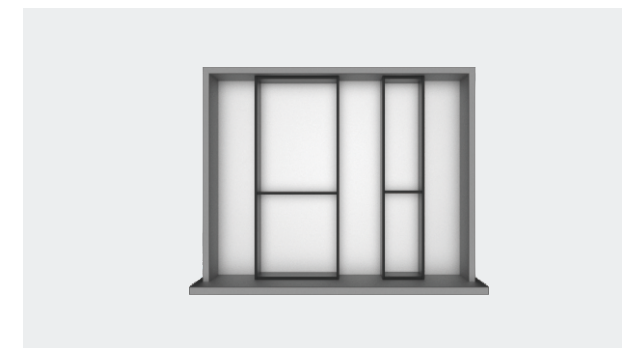

NL标称长度	产品编号	柜体宽度
350-550mm	5313XXX*1+5314XXX*1	600-700mm

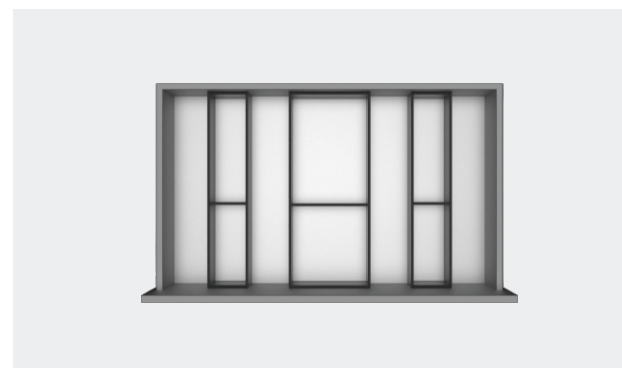

NL标称长度	产品编号	柜体宽度
350-550mm	5313XXX*2+5314XXX*1	800-900mm

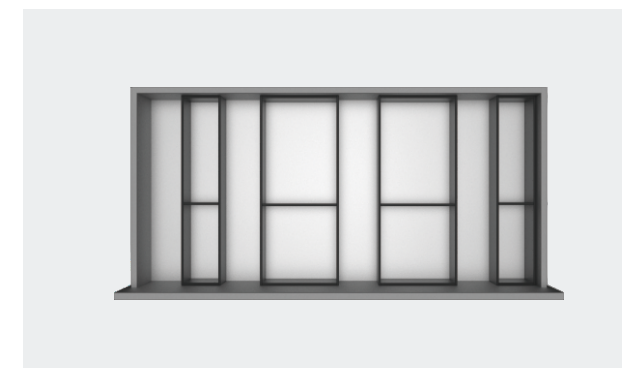

NL标称长度	产品编号	柜体宽度
350-550mm	5313XXX*2+5314XXX*2	1000-1200mm



产品详情电子版



产品编号	包装数量	KB柜体宽度	可放置提盘器数量
GR2361	10PCS	400-600MM	2PCS
		800-900MM	4PCS
		1000-1200MM	6PCS

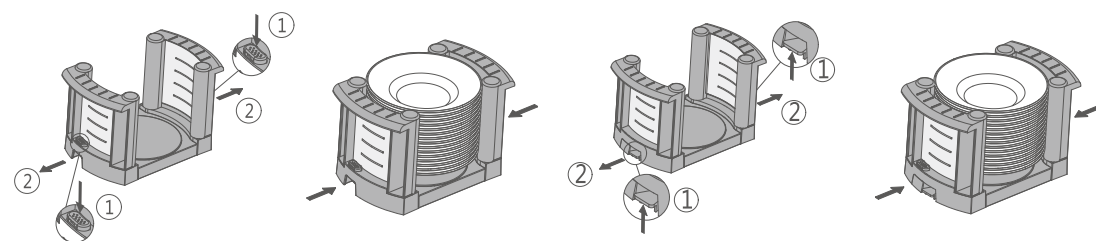

产品详情电子版

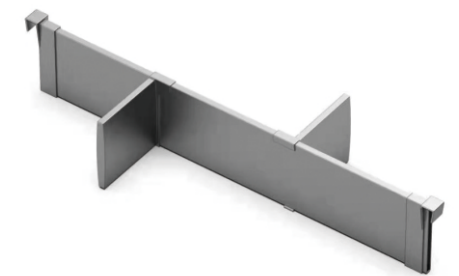
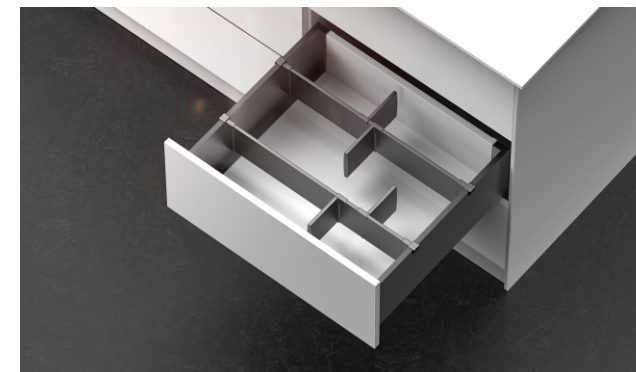

产品编号	产品名称	规格	颜色	包装数量	产品组合
G130600G	横隔板	600mm	铁灰	20PCS	裁切尺寸LW-48mm
G131200G	横隔板	1200mm	铁灰	20PCS	裁切尺寸LW-48mm
G130600W	横隔板	600mm	丝光白	20PCS	裁切尺寸LW-48mm
G131200W	横隔板	1200mm	丝光白	20PCS	裁切尺寸LW-48mm
G13001G	横隔板连接件		铁灰	20PCS	
G13001W	横隔板连接件		丝光白	20PCS	
G13002G	竖隔板		铁灰	20PCS	
G13002W	竖隔板		丝光白	20PCS	